

1 YEAR
WARRANTY

MADE IN
USA

CE

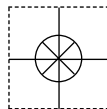

User's Guide



Standard

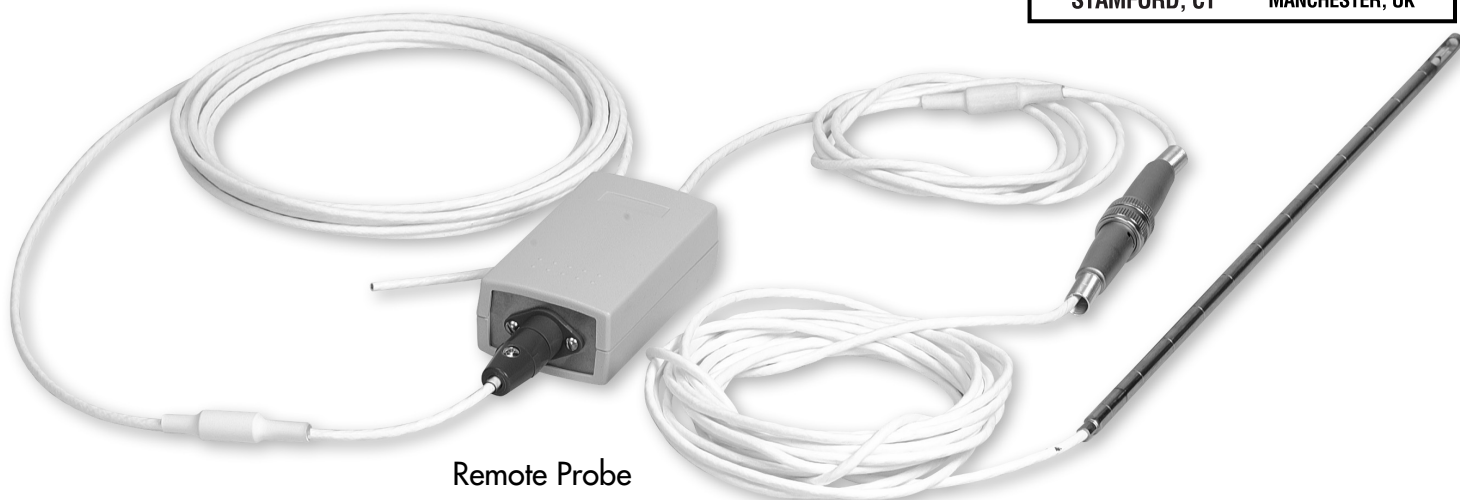

Remote Probe

Shop online at

omega.com[®]

Ω OMEGA[®]

omega.com

e-mail: info@omega.com

For latest product manuals:

omegamanual.info

ISO 9001
CERTIFIED
CORPORATE QUALITY

STAMFORD, CT

ISO 9002
CERTIFIED
CORPORATE QUALITY

MANCHESTER, UK

FMA-900 SERIES Air Velocity Transducers



OMEGAnet® Online Service
omega.com

Internet e-mail
info@omega.com

Servicing North America:

USA:
ISO 9001 Certified

One Omega Drive, P.O. Box 4047
Stamford CT 06907-0047
TEL: (203) 359-1660 FAX: (203) 359-7700
e-mail: info@omega.com

Canada:

976 Bergar
Laval (Quebec) H7L 5A1, Canada
TEL: (514) 856-6928 FAX: (514) 856-6886
e-mail: info@omega.ca

For immediate technical or application assistance:

USA and Canada: Sales Service: 1-800-826-6342 / 1-800-TC-OMEGA®
Customer Service: 1-800-622-2378 / 1-800-622-BEST®
Engineering Service: 1-800-872-9436 / 1-800-USA-WHEN®
TELEX: 996404 EASYLINK: 62968934 CABLE: OMEGA

Mexico:

En Español: (001) 203-359-7803 e-mail: espanol@omega.com
FAX: (001) 203-359-7807 info@omega.com.mx

Servicing Europe:

Benelux:

Postbus 8034, 1180 LA Amstelveen, The Netherlands
TEL: +31 (0)20 3472121 FAX: +31 (0)20 6434643
Toll Free in Benelux: 0800 0993344
e-mail: sales@omegaeng.nl

Czech Republic:

Frystatska 184, 733 01 Karviná, Czech Republic
TEL: +420 (0)59 6311899 FAX: +420 (0)59 6311114
Toll Free: 0800-1-66342 e-mail: info@omegashop.cz

France:

11, rue Jacques Cartier, 78280 Guyancourt, France
TEL: +33 (0)1 61 37 2900 FAX: +33 (0)1 30 57 5427
Toll Free in France: 0800 466 342
e-mail: sales@omega.fr

Germany/Austria:

Daimlerstrasse 26, D-75392 Deckenpfronn, Germany
TEL: +49 (0)7056 9398-0 FAX: +49 (0)7056 9398-29
Toll Free in Germany: 0800 639 7678
e-mail: info@omega.de

United Kingdom:

ISO 9002 Certified

One Omega Drive, River Bend Technology Centre
Northbank, Irlam, Manchester
M44 5BD United Kingdom
TEL: +44 (0)161 777 6611 FAX: +44 (0)161 777 6622
Toll Free in United Kingdom: 0800-488-488
e-mail: sales@omega.co.uk

It is the policy of OMEGA to comply with all worldwide safety and EMC/EMI regulations that apply. OMEGA is constantly pursuing certification of its products to the European New Approach Directives. OMEGA will add the CE mark to every appropriate device upon certification.

The information contained in this document is believed to be correct, but OMEGA Engineering, Inc. accepts no liability for any errors it contains, and reserves the right to alter specifications without notice.

WARNING: These products are not designed for use in, and should not be used for, human applications.



General Description

The OMEGA® FMA-900 air velocity mass flow transducer is ideal for economical monitoring of clean air flows in ducts and pipes, while producing very little permanent pressure drop in the flowstream. The FMA-900 employs two rugged glass-coated RTD elements, protected by a 1/4" diameter 304SS tube with a "window" cut out. One RTD is the velocity sensor, while the other RTD provides ambient air temperature compensation. The velocity sensor is heated to maintain a constant (approximately 30° C) temperature differential above the ambient air temperature, as measured by the second RTD element. The cooling effect of the air flow experienced by the velocity sensor is measured and converted to an electrical output signal proportional to air velocity. The FMA-900 is provided with a 13" long probe as standard. The 304SS tubing is provided with inch marks for ease of insertion depth.

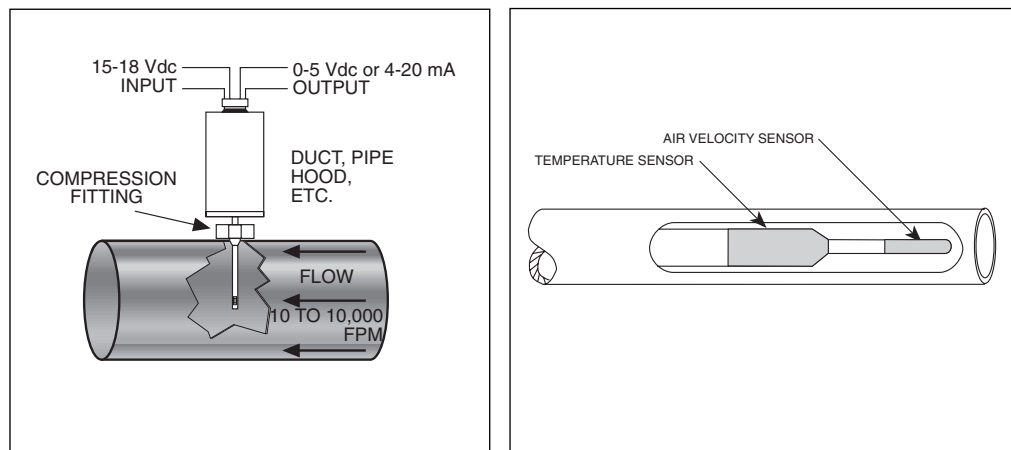

Unpacking

Remove the Packing List and verify that you have received all equipment. If you have any questions about the shipment, please call the OMEGA Customer Service Department.

Upon receipt of shipment, inspect the container and equipment for any sign of damage. Note any evidence of rough handling in transit. Immediately report any damage to the shipping agent.

NOTE

The carrier will not honor any claims unless all shipping material is saved for their examination. After examining and removing contents, save packing material in the event reshipment is necessary.

The following items are supplied with the FMA-900:

- FMA-900 Series Air Velocity Transducer
- Mating connector
- Removable plastic protective cover (supplied on the sensor tip)
- Operator's manual

Important Considerations Before Installation

CAUTION

The FMA-900 air velocity transducer is not explosion-proof, nor is it intrinsically safe. Do not use for flammable or hazardous gases, or in hazardous areas.



The FMA-900 air velocity transducer is intended for use with clean air or nitrogen ONLY. Do not use with other gases, as other gases will produce an uncalibrated, non-linear output signal. In addition, air carrying dust or oil (such as found in blower/compressor systems that utilize oil) can lead to coating of the sensor and thus, inaccurate readings. Refer to the Maintenance section for more information on cleaning the sensor.

The FMA-900 is a bi-directional device; flow in the forward or reverse direction provides the same output.

Installing the Flowmeter

The FMA-900 air velocity transducer can be mounted vertically or horizontally without shift in calibration.

1. Remove the plastic protective cap from the sensor tip.
2. Run a length of straight pipe before and after the flowmeter. The amount of upstream straight pipe run required depends upon the type of obstruction which is immediately upstream of the flow sensor. See Table 2-1 for specific requirements. Downstream of the flow sensor, in all situations, run 5 diameters of straight pipe, regardless of the downstream obstruction.
3. Align the FMA-900 with the air flow. Make sure the width of the electronics box (2 inches) is parallel with the flow stream.

The score line on the tubing is another way of aligning the air flow sensor with the flow stream. The score line starts from the center of the transducer window and as a result it can be aligned properly.

One means of installing the probe into a flow stream is to utilize a compression fitting, such as OMEGA's SSLK-14-14 stainless steel compression fitting with Teflon ferrules, which permits adjustment of the insertion depth of the probe.

On Remote Probe Models (-R), connect the remote probe cable to the Electronic Housing.



Table 2-1 Piping Requirements

	Typical Piping	Recommended Straight Pipe Length "A"		Remarks
		Without Vanes	With Vanes	
All Fittings in Same Plane		15D	15D	Closed Branch
		20D	15D	Elbow, Tee, Branch Pipe
		25D	15D	Elbow, 2 planes
		25D	15D	Long-radius bends
Fittings in Two Planes		30D 25D	15D 15D	Elbow Long-radius bends
		40D 35D	15D 15D	Elbow Long-radius bends
Varied Section		20D	15D	Contracting Pipe
		40D	20D	Expanding Pipe
Valves		Recommend Meter Be Installed Upstream		Regulating, reducing valves Ball, check valves Shut-off valves

Note: Straight pipe length on the downstream side to be 5 pipe diameters minimum.
 * D – Pipe internal diameter.

Wiring the Flowmeter

1. Connect pins as follows:

<u>PLUG PIN NO.</u>	<u>DESCRIPTION</u>
1	0-5 VDC or 4-20 mA Output (-)
2	0-5 VDC or 4-20 mA Output (+)
3	Power Supply (+)
4	No Connection
5	No Connection
6	Power Supply (-)

2. Blow clean air through the FMA-900.
3. Install the sensor into the pipe or duct.

Measuring Air Flow

The FMA-900 measures standard velocity, which is the mass velocity of the air referenced to 25° C and 760 mm Hg. No temperature or pressure corrections are required. Where SCFM (standard cubic feet per minute) measurements are desired:

1. Locate the point of average velocity in the pipe or duct.
2. In round pipes, under turbulent flow conditions (where the Reynolds number is greater than 5,000), mount the velocity sensor approximately 1/8 of a pipe diameter in from the the pipe wall. For example, in an 8" diameter pipe, mount the probe 1" in from the pipe wall.
3. For pipes or ducts where the flow is not turbulent, or the flow profile is not symmetrical (due to inadequate straight pipe runs, etc.), perform a traverse of the duct, in accordance with standard duct traversal methods as recommended by ASHRAE or the National Air Balance Council.
4. To obtain SCFM, once the probe is mounted in the location of average velocity, multiply the average velocity readings (in SFPM, standard feet per minute) by the cross-sectional area of the pipe or duct, in square feet. For standard pipe, these values can be found in the technical section of the OMEGA Complete Flow and Level Measurement Handbook and Encyclopedia®.

Maintenance

Except for intermittent removal of the sensor from the line for cleaning, there is no routine maintenance for the FMA-900. If the probe becomes coated with dust, blow the dust away with clean air. If the probe is coated with sticky material, clean it with a solvent which is compatible with epoxy, glass, and 304SS, and which will not leave a residue on the sensor. You may clean the sensor with water or alcohol (Ethanol) and an artist's brush.

Calibration

Each FMA-900 is individually calibrated in a NIST-traceable wind tunnel. For calibration certification or calibrating to a new range, the unit must be returned to OMEGA. To obtain an Authorized Return (AR) number, call the OMEGA Customer Service Department with a Purchase Order number to cover the recalibration charges.



Specifications









Ranges:

<u>Model No.</u> <u>0-5 V Output</u>	<u>Model No.</u> <u>4-20 mA Output</u>	<u>Range</u>
FMA-900-V	FMA-900-I	0-100 SFPM
FMA-901-V	FMA-901-I	0-200 SFPM
FMA-902-V	FMA-902-I	0-500 SFPM
FMA-903-V	FMA-903-I	0-1000 SFPM
FMA-904-V	FMA-904-I	0-2000 SFPM
FMA-905-V	FMA-905-I	0-5000 SFPM
FMA-906-V	FMA-906-I	0-10,000 SFPM

Accuracy:	±1.5% of Full Scale at room temperature. Add ± 0.5% of reading from 32 to 122°. Add 1% Full Scale below 1,000 SFPM.
Repeatability:	± 0.2% of Full Scale
Response Time:	400 milliseconds to within 63% of final value at room temperature
Probe:	Aluminum oxide ceramic glass coating and epoxy; probe body 304SS
Probe Temperature/Pressure:	-40 to 250°F (-40 to 121°C); 150 PSIG maximum
Remote Probe (-R):	Available with 15' (4.6m) shielded cable between the Probe and the Electronic Housing
Electronics Temperature Range:	Operating: 32 to 122°F (0 to 50°C) Storage: 32 to 158°F (0 to 70°C)
Ambient Temperature Compensation:	About 5 minutes for 20°F ambient temperature change
Power:	15 to 18 Vdc at 300 mA (15 to 24 Vdc at 300 mA for 0-100 SFPM and 0-200 SFPM ranges)
Output Load Resistance:	Voltage: 250 ohms minimum Current: 0-400 ohms maximum; 4-wire
Accessories:	Mating connector prewired to 15 feet shielded cable with built-in ferrite core included
Dimensions:	Case: 3.5"H x 2"W x 1.25"D (89mm H x 51mm W x 31.8 mm D) Probe: 1/4" (6.35mm) O.D., 13" long standard (330 mm), 3.75" long optional ("-S")
Weight:	0.35 lbs. (0.16 kg)

OTHER IMPORTANT CONSIDERATIONS BEFORE INSTALLATION

CAUTION

-  Follow All Safety Precautions and Operating Instructions Outlined in this Manual.
-  The Unit May be Powered from a DC Power Supply. The Power Supply Should Have Integral Impedence Protection.
-  Recommended Wiring Cable: Shielded 4-Conductor Cable, 22 or 24 AWG Stranded.
-  Recommended Power Supply Rating: 0-24 Vdc @ 300 mA, 7.2 VA
-  There are No User Replaceable Fuse in this Product.
-  Avoid Contact with Hazardous Live Parts.
-  Do Not Operate in Flammable or Explosive Environments.
-  This Product is for Use Only with Equipment which has no Accessible Live Parts.

TYPICAL INSTALLATION SCHEMATIC

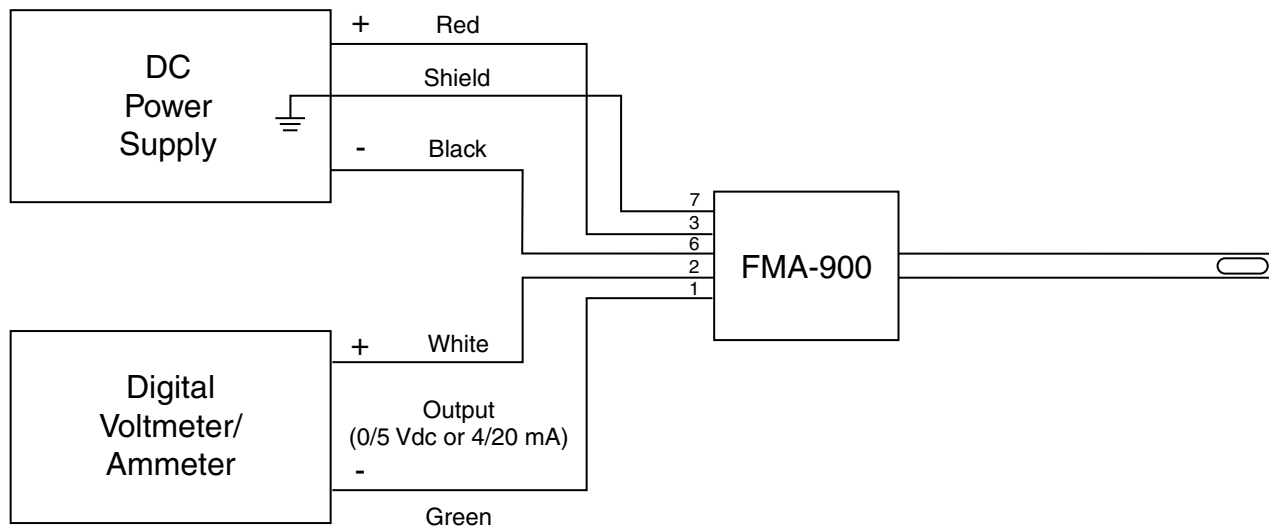



WARRANTY/DISCLAIMER

OMEGA ENGINEERING, INC. warrants this unit to be free of defects in materials and workmanship for a period of **13 months** from date of purchase. OMEGA's WARRANTY adds an additional one (1) month grace period to the normal **one (1) year product warranty** to cover handling and shipping time. This ensures that OMEGA's customers receive maximum coverage on each product.

If the unit malfunctions, it must be returned to the factory for evaluation. OMEGA's Customer Service Department will issue an Authorized Return (AR) number immediately upon phone or written request. Upon examination by OMEGA, if the unit is found to be defective, it will be repaired or replaced at no charge. OMEGA's WARRANTY does not apply to defects resulting from any action of the purchaser, including but not limited to mishandling, improper interfacing, operation outside of design limits, improper repair, or unauthorized modification. This WARRANTY is VOID if the unit shows evidence of having been tampered with or shows evidence of having been damaged as a result of excessive corrosion; or current, heat, moisture or vibration; improper specification; misapplication; misuse or other operating conditions outside of OMEGA's control. Components which wear are not warranted, including but not limited to contact points, fuses, and triacs.

OMEGA is pleased to offer suggestions on the use of its various products. However, OMEGA neither assumes responsibility for any omissions or errors nor assumes liability for any damages that result from the use of its products in accordance with information provided by OMEGA, either verbal or written. OMEGA warrants only that the parts manufactured by it will be as specified and free of defects. OMEGA MAKES NO OTHER WARRANTIES OR REPRESENTATIONS OF ANY KIND WHATSOEVER, EXPRESS OR IMPLIED, EXCEPT THAT OF TITLE, AND ALL IMPLIED WARRANTIES INCLUDING ANY WARRANTY OF MERCHANTABILITY AND FITNESS FOR A PARTICULAR PURPOSE ARE HEREBY DISCLAIMED. LIMITATION OF LIABILITY: The remedies of purchaser set forth herein are exclusive, and the total liability of OMEGA with respect to this order, whether based on contract, warranty, negligence, indemnification, strict liability or otherwise, shall not exceed the purchase price of the component upon which liability is based. In no event shall OMEGA be liable for consequential, incidental or special damages.

CONDITIONS: Equipment sold by OMEGA is not intended to be used, nor shall it be used: (1) as a "Basic Component" under 10 CFR 21 (NRC), used in or with any nuclear installation or activity; or (2) in medical applications or used on humans. Should any Product(s) be used in or with any nuclear installation or activity, medical application, used on humans, or misused in any way, OMEGA assumes no responsibility as set forth in our basic WARRANTY/DISCLAIMER language, and, additionally, purchaser will indemnify OMEGA and hold OMEGA harmless from any liability or damage whatsoever arising out of the use of the Product(s) in such a manner.

RETURN REQUESTS/INQUIRIES

Direct all warranty and repair requests/inquiries to the OMEGA Customer Service Department. BEFORE RETURNING ANY PRODUCT(S) TO OMEGA, PURCHASER MUST OBTAIN AN AUTHORIZED RETURN (AR) NUMBER FROM OMEGA'S CUSTOMER SERVICE DEPARTMENT (IN ORDER TO AVOID PROCESSING DELAYS). The assigned AR number should then be marked on the outside of the return package and on any correspondence.

The purchaser is responsible for shipping charges, freight, insurance and proper packaging to prevent breakage in transit.

FOR **WARRANTY** RETURNS, please have the following information available BEFORE contacting OMEGA:

1. Purchase Order number under which the product was PURCHASED,
2. Model and serial number of the product under warranty, and
3. Repair instructions and/or specific problems relative to the product.

FOR **NON-WARRANTY** REPAIRS, consult OMEGA for current repair charges. Have the following information available BEFORE contacting OMEGA:

1. Purchase Order number to cover the COST of the repair,
2. Model and serial number of the product, and
3. Repair instructions and/or specific problems relative to the product.

OMEGA's policy is to make running changes, not model changes, whenever an improvement is possible. This affords our customers the latest in technology and engineering.

OMEGA is a registered trademark of OMEGA ENGINEERING, INC.

© Copyright 2004 OMEGA ENGINEERING, INC. All rights reserved. This document may not be copied, photocopied, reproduced, translated, or reduced to any electronic medium or machine-readable form, in whole or in part, without the prior written consent of OMEGA ENGINEERING, INC.

Where Do I Find Everything I Need for Process Measurement and Control? **OMEGA...Of Course!** *Shop online at omega.com*

TEMPERATURE

- ☑ Thermocouple, RTD & Thermistor Probes, Connectors, Panels & Assemblies
- ☑ Wire: Thermocouple, RTD & Thermistor
- ☑ Calibrators & Ice Point References
- ☑ Recorders, Controllers & Process Monitors
- ☑ Infrared Pyrometers

PRESSURE, STRAIN AND FORCE

- ☑ Transducers & Strain Gages
- ☑ Load Cells & Pressure Gages
- ☑ Displacement Transducers
- ☑ Instrumentation & Accessories

FLOW/LEVEL

- ☑ Rotameters, Gas Mass Flowmeters & Flow Computers
- ☑ Air Velocity Indicators
- ☑ Turbine/Paddlewheel Systems
- ☑ Totalizers & Batch Controllers

pH/CONDUCTIVITY

- ☑ pH Electrodes, Testers & Accessories
- ☑ Benchtop/Laboratory Meters
- ☑ Controllers, Calibrators, Simulators & Pumps
- ☑ Industrial pH & Conductivity Equipment

DATA ACQUISITION

- ☑ Data Acquisition & Engineering Software
- ☑ Communications-Based Acquisition Systems
- ☑ Plug-in Cards for Apple, IBM & Compatibles
- ☑ Datalogging Systems
- ☑ Recorders, Printers & Plotters

HEATERS

- ☑ Heating Cable
- ☑ Cartridge & Strip Heaters
- ☑ Immersion & Band Heaters
- ☑ Flexible Heaters
- ☑ Laboratory Heaters

ENVIRONMENTAL MONITORING AND CONTROL

- ☑ Metering & Control Instrumentation
- ☑ Refractometers
- ☑ Pumps & Tubing
- ☑ Air, Soil & Water Monitors
- ☑ Industrial Water & Wastewater Treatment
- ☑ pH, Conductivity & Dissolved Oxygen Instruments